

SECTION IV

ELECTRONICS AND WIRING DIAGRAMS

	Page
Display Console Board - Model LC9500	3
Display Console Board - Model LC9100	6
Display Console Board - Model LC8500	8
Display Console Board - Model C7	10
Display Console Board - Model C9	12
Alternator Control Board - Model C7 and LC8500	14
Alternator Control Board - Model C9, LC9100, and LC9500	15
Alternator	17
Wiring Block Diagram LC8500 and C7	18
Wiring Block Diagram C9	19
Wiring Block Diagram LC9100	20
Wiring Block Diagram LC9500	21
Wiring Block Diagram 95CE Single Power Control Board	22
Wiring Block Diagram 95CE Power Control Board	23
Wiring Block Diagram 95CE Machine Interface Board	24
Wiring Block Diagram 95CE Single Board Computer	25
Notes	26

Lifecycle Upright Bikes LC95, LC91, LC85, C9, C7, 95Ce, 95Ci, 93Ci, and 90C

Notes

**Lifecycle Upright Bikes LC95, LC91, LC85, C9, C7, 95Ce, 95Ci, 93Ci, and 90C
DISPLAY CONSOLE BOARD - Model LC9500**

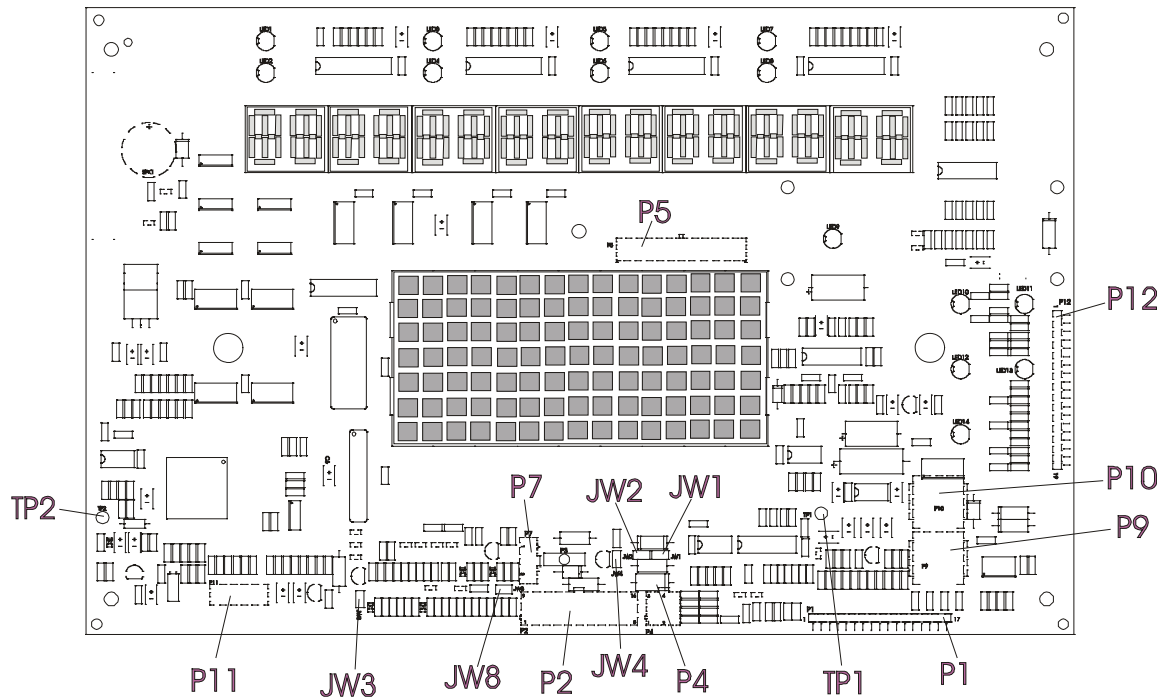

Functional Description





The Display Console Board is designed to work in conjunction with the Alternator Control Board. It reads the keypad input for changes or updates by the user, and refreshes the status LEDs, data display, and profile display matrix.

Connector and Pin Descriptions

Connector	Location	Pin	Functional Description
P1 and P12 is a 17 pin ribbon connector that connects to the switch membrane.		1	Ground
		2	Strobe
		3	Return
		4	Strobe
		5	Strobe
		6	Return
		7	Strobe
		8	Return
		9	Strobe
		10	Return
		11	Ground
		12	Strobe
		13	Strobe
		14	Return
		15	Strobe
		16	Return
		17	Ground

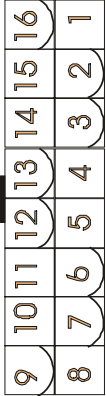
**Lifecycle Upright Bikes LC95, LC91, LC85, C9, C7, 95Ce, 95Ci, 93Ci, and 90C
DISPLAY CONSOLE BOARD - Model LC9500**

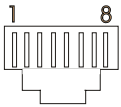
Connector and Pin Descriptions

Connector	Location	Pin	Functional Description
P2 is a 16 pin connector that connects to the alternator control board.		1	N.C.
		2	GND (NOT USED)
		3	VSYS (NOT USED)
		4	VBAT (NOT USED)
		5	RPM REED (NOT USED)
		6	RPM ALT
		7	ASTART (NOT USED)
		8	VALT. (NOT USED)
		9	RELAY (NOT USED)
		10	GND
		11	GND
		12	VBAT
		13	FIELD-KICK
		14	FIELD
		15	LOAD-CMD
		16	VSYS
P4 is 4 pin connector that connects to the heart rate sensor.			LEFT +
			LEFT -
			RIGHT -
			RIGHT +
P7 is a 3 pin connector that connects to the polar signal.		1	+VCC (5VDC)
		2	POLAR SIGNAL
		3	GROUND
P9 and P10 are 8 pin connectors that connect to the CSAFE and Cardio Theater or broadcast vision interface.		1	N/U - not used
		2	N/U - not used
		3	Receive Data
		4	Transmit Data
		5	+8 Vdc
		6	CTS
		7	Ground
		8	N/U - not used
P11 is a 10 pin connector that connects to the background debug mode signals.		1	/DS
		2	/BERR
		3	Ground
		4	/BKPT /DSCLK
		5	Ground
		6	FREEZE/QUOT
		7	/RESET
		8	IPIPE1/DS1
		9	+5 Vdc
		10	IPIPE0/DS0

**Lifecycle Upright Bikes LC95, LC91, LC85, C9, C7, 95Ce, 95Ci, 93Ci, and 90C
 DISPLAY CONSOLE BOARD - Model LC9500**

Connector and Pin Descriptions

Connector	Location	Pin	Functional Description																																																
P5 is a 24 pin connector that connects to the lower console display board.	<table border="1" style="border-collapse: collapse; text-align: center; width: 100%;"> <tr> <td style="width: 50%;">24</td> <td style="width: 50%;">1</td> </tr> <tr> <td>23</td> <td>2</td> </tr> <tr> <td>22</td> <td>3</td> </tr> <tr> <td>21</td> <td>4</td> </tr> <tr> <td>20</td> <td>5</td> </tr> <tr> <td>19</td> <td>6</td> </tr> <tr> <td>18</td> <td>7</td> </tr> <tr> <td>17</td> <td>8</td> </tr> <tr> <td>16</td> <td>9</td> </tr> <tr> <td>15</td> <td>10</td> </tr> <tr> <td>14</td> <td>11</td> </tr> <tr> <td>13</td> <td>12</td> </tr> <tr> <td>12</td> <td>13</td> </tr> <tr> <td>11</td> <td>14</td> </tr> <tr> <td>10</td> <td>15</td> </tr> <tr> <td>9</td> <td>16</td> </tr> <tr> <td>8</td> <td>17</td> </tr> <tr> <td>7</td> <td>18</td> </tr> <tr> <td>6</td> <td>19</td> </tr> <tr> <td>5</td> <td>20</td> </tr> <tr> <td>4</td> <td>21</td> </tr> <tr> <td>3</td> <td>22</td> </tr> <tr> <td>2</td> <td>23</td> </tr> <tr> <td>1</td> <td>24</td> </tr> </table>	24	1	23	2	22	3	21	4	20	5	19	6	18	7	17	8	16	9	15	10	14	11	13	12	12	13	11	14	10	15	9	16	8	17	7	18	6	19	5	20	4	21	3	22	2	23	1	24	1	
		24	1																																																
		23	2																																																
		22	3																																																
		21	4																																																
		20	5																																																
		19	6																																																
		18	7																																																
		17	8																																																
		16	9																																																
		15	10																																																
		14	11																																																
		13	12																																																
		12	13																																																
		11	14																																																
		10	15																																																
		9	16																																																
		8	17																																																
		7	18																																																
		6	19																																																
		5	20																																																
		4	21																																																
		3	22																																																
		2	23																																																
1	24																																																		
2																																																			
3																																																			
4																																																			
5																																																			
6																																																			
7																																																			
8																																																			
9																																																			
10																																																			
11																																																			
12																																																			
13																																																			
14																																																			
15																																																			
16																																																			
17																																																			
18																																																			
19																																																			
20																																																			
21																																																			
22																																																			
23																																																			
24																																																			

**Lifecycle Upright Bikes LC95, LC91, LC85, C9, C7, 95Ce, 95Ci, 93Ci, and 90C
DISPLAY CONSOLE BOARD - Model LC9100**

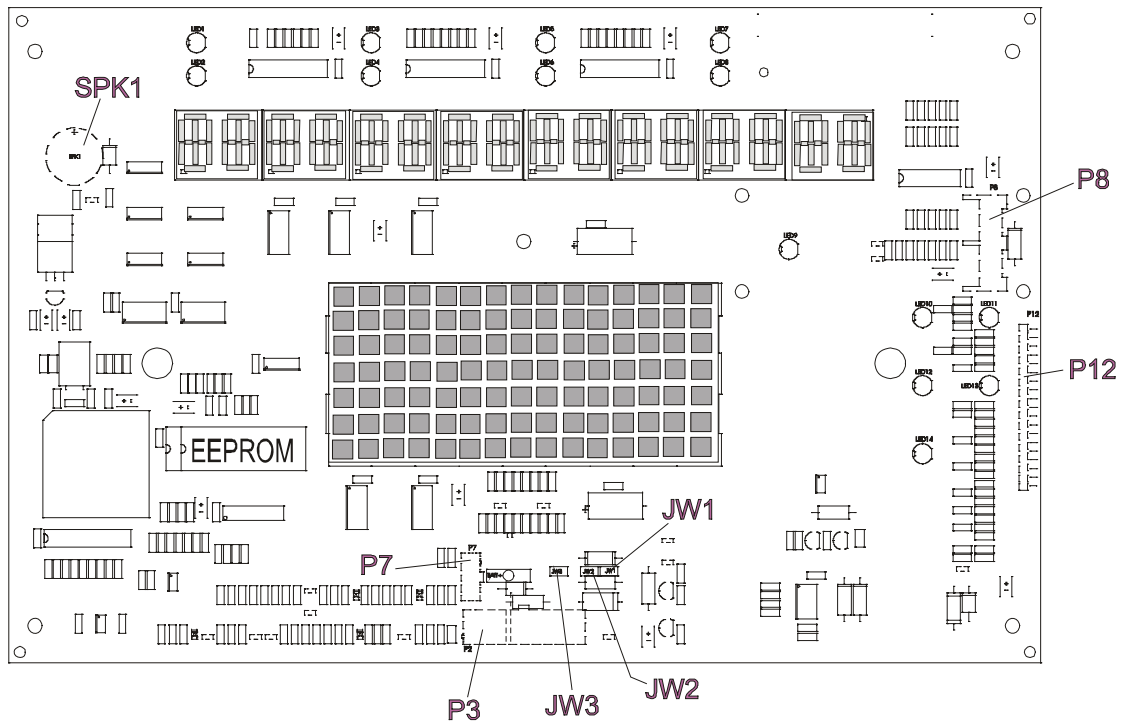

Functional Description



The Display Console Board is designed to work in conjunction with the Alternator Control Board. It reads the keypad input for changes or updates by the user, and refreshes the status LEDs, data display, and profile display matrix.

Connector and Pin Descriptions

Connector	Location	Pin	Functional Description
P12 is a 17 pin ribbon connector that connects to the switch membrane.		1	Ground
		2	Strobe
		3	Return
		4	Strobe
		5	Strobe
		6	Return
		7	Strobe
		8	Return
		9	Strobe
		10	Return
		11	Ground
		12	Strobe
		13	Strobe
		14	Return
		15	Strobe
		16	Return
		17	Ground

**Lifecycle Upright Bikes LC95, LC91, LC85, C9, C7, 95Ce, 95Ci, 93Ci, and 90C
DISPLAY CONSOLE BOARD - Model LC9100**

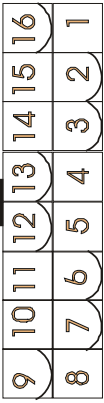
Connector and Pin Descriptions

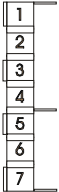
Connector	Location	Pin	Functional Description
P2 is a 16 pin connect that connects to the alternator control board.		1	N.C.
		2	GND (NOT USED)
		3	VSYS (NOT USED)
		4	VBAT (NOT USED)
		5	RPM REED (NOT USED)
		6	RPM ALT
		7	ASTART (NOT USED)
		8	VALT. (NOT USED)
		9	RELAY (NOT USED)
		10	GND
		11	GND
		12	VBAT
		13	FIELD-KICK
		14	FIELD
		15	LOAD-CMD
		16	VSYS
P7 is a 3 pin connector that connects to the polar signal.		1	+VCC (5VDC)
		2	POLAR SIGNAL
		3	GROUND
P8 is an 7 pin connector that connects to the CSAFE card.		1	GND
		2	LEU
		3	TDO
		4	RDI
		5	CTS
		6	VCC
		7	V CARDIO

**Lifecycle Upright Bikes LC95, LC91, LC85, C9, C7, 95Ce, 95Ci, 93Ci, and 90C
DISPLAY CONSOLE BOARD - Model LC8500**

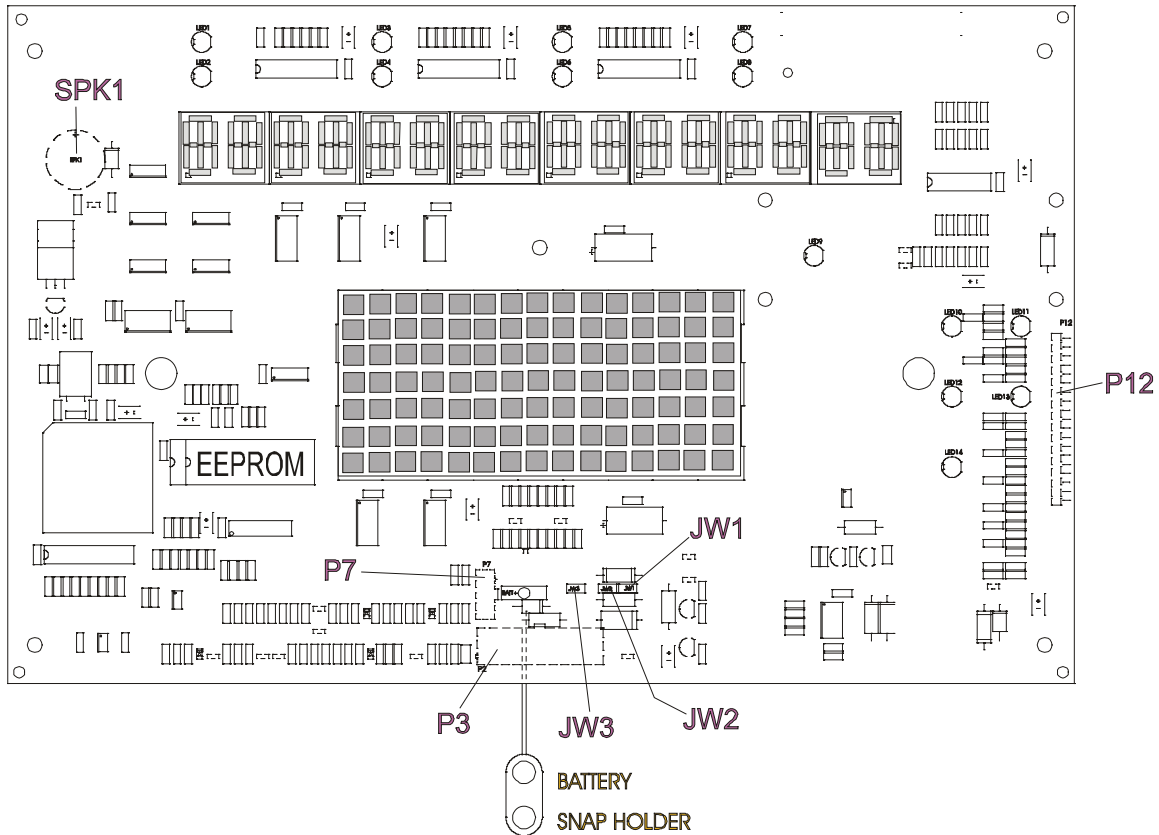

Functional Description



The Display Console Board is designed to work in conjunction with the Alternator Control Board. It reads the keypad input for changes or updates by the user, and refreshes the status LEDs, data display, and profile display matrix.

Connector and Pin Descriptions

Connector	Location	Pin	Functional Description
P12 is a 17 pin ribbon connector that connects to the switch membrane.		1	Ground
		2	Strobe
		3	Return
		4	Strobe
		5	Strobe
		6	Return
		7	Strobe
		8	Return
		9	Strobe
		10	Return
		11	Ground
		12	Strobe
		13	Strobe
		14	Return
		15	Strobe
		16	Return
		17	Ground

**Lifecycle Upright Bikes LC95, LC91, LC85, C9, C7, 95Ce, 95Ci, 93Ci, and 90C
DISPLAY CONSOLE BOARD - Model LC8500**

Connector and Pin Descriptions

Connector	Location	Pin	Functional Description
P2 is a 16 pin connector that connects to the alternator control board.		1	N.C.
		2	GND (NOT USED)
		3	VSYS (NOT USED)
		4	VBAT (NOT USED)
		5	RPM REED (NOT USED)
		6	RPM ALT
		7	ASTART (NOT USED)
		8	VALT (NOT USED)
		9	RELAY (NOT USED)
		10	GND
		11	GND
		12	VBAT
		13	FIELD-KICK
		14	FIELD
		15	LOAD-CMD
		16	VSYS
P7 is a 3 pin connector that connects the polar connector.		1	+VCC (5VDC)
		2	POLAR SIGNAL
		3	GROUND

**Lifecycle Upright Bikes LC95, LC91, LC85, C9, C7, 95Ce, 95Ci, 93Ci, and 90C
DISPLAY CONSOLE BOARD - Model C7**

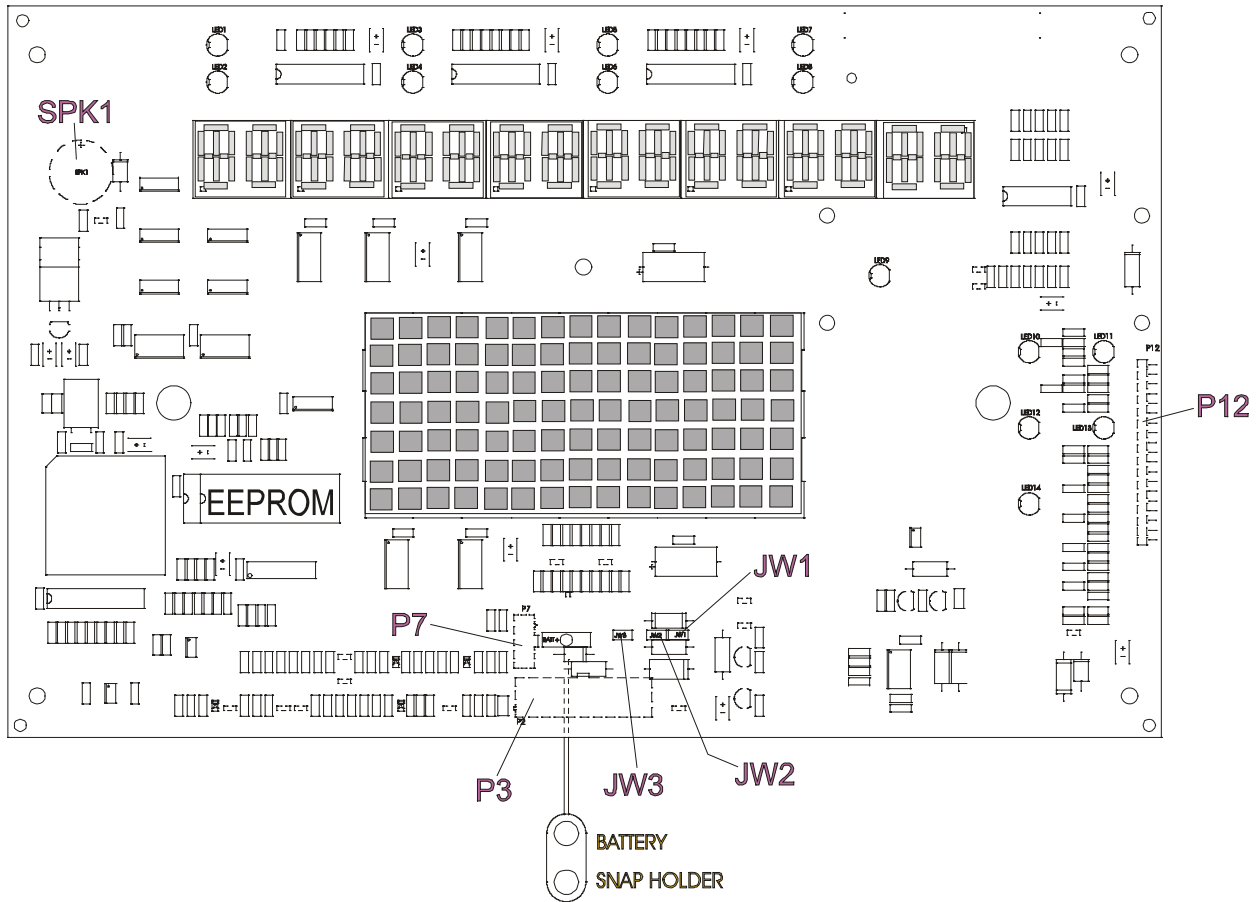

Functional Description

The Display Console Board is designed to work in conjunction with the Alternator Control Board. It reads the keypad input for changes or updates by the user, and refreshes the status LEDs, data display, and profile display matrix.

Connector and Pin Descriptions

Connector	Location	Pin	Functional Description
P12 is a 17 pin ribbon connector that connects to the overlay board.		1	Ground
		2	Strobe
		3	Return
		4	Strobe
		5	Strobe
		6	Return
		7	Strobe
		8	Return
		9	Strobe
		10	Return
		11	Ground
		12	Strobe
		13	Strobe
		14	Return
		15	Strobe
		16	Return
		17	Ground

**Lifecycle Upright Bikes LC95, LC91, LC85, C9, C7, 95Ce, 95Ci, 93Ci, and 90C
DISPLAY CONSOLE BOARD - Model C7**

Connector and Pin Descriptions

Connector	Location	Pin	Functional Description
P2 is a 16 pin connector that connects to the alternator control board.		1	N.C.
		2	GND (NOT USED)
		3	VSYS (NOT USED)
		4	VBAT (NOT USED)
		5	RPM REED (NOT USED)
		6	RPM ALT
		7	ASTART (NOT USED)
		8	VALT. (NOT USED)
		9	RELAY (NOT USED)
		10	GND
		11	GND
		12	VBAT
		13	FIELD-KICK
		14	FIELD
		15	LOAD-CMD
		16	VSYS
P7 is a 3 pin connector that to the polar connector.		1	+VCC (5VDC)
		2	POLAR SIGNAL
		3	GROUND

**Lifecycle Upright Bikes LC95, LC91, LC85, C9, C7, 95Ce, 95Ci, 93Ci, and 90C
DISPLAY CONSOLE BOARD - Model C9**

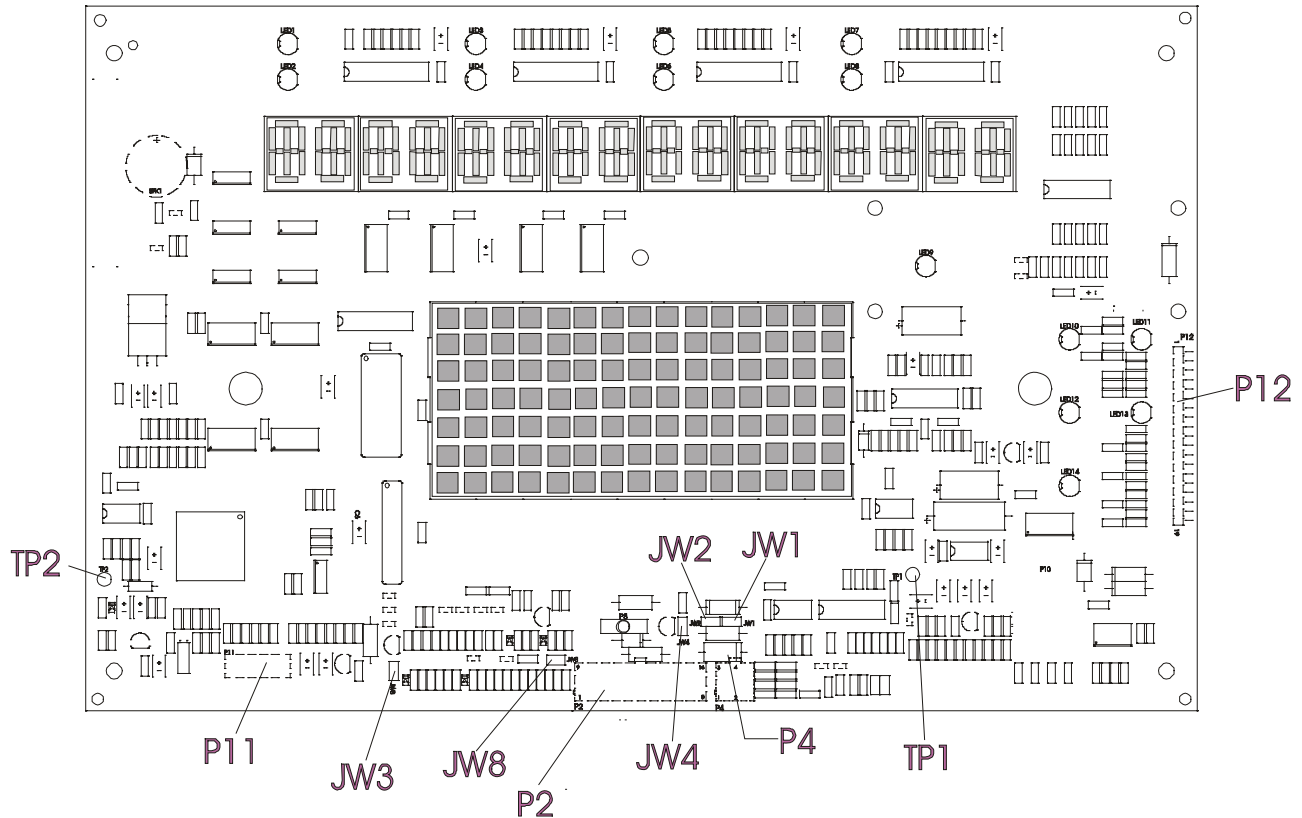

Functional Description

The Display Console Board is designed to work in conjunction with the Alternator Control Board. It reads the keypad input for changes or updates by the user, and refreshes the status LEDs, data display, and profile display matrix.

Connectors and Pin Descriptions

Connector	Location	Pin	Functional Description
P12 is a 17 pin ribbon connector that connects to the overlay board.		1	Ground
		2	Strobe
		3	Return
		4	Strobe
		5	Strobe
		6	Return
		7	Strobe
		8	Return
		9	Strobe
		10	Return
		11	Ground
		12	Strobe
		13	Strobe
		14	Return
		15	Strobe
		16	Return
		17	Ground

**Lifecycle Upright Bikes LC95, LC91, LC85, C9, C7, 95Ce, 95Ci, 93Ci, and 90C
DISPLAY CONSOLE BOARD - Model C9**

Connector and Pin Descriptions

Connector	Location	Pin	Functional Description
P2 is a 16 pin connector that connects to the alternator control board.		1	N.C.
		2	GND (NOT USED)
		3	VSYS (NOT USED)
		4	VBAT (NOT USED)
		5	RPM REED (NOT USED)
		6	RPM ALT
		7	ASTART (NOT USED)
		8	VALT. (NOT USED)
		9	RELAY (NOT USED)
		10	GND
		11	GND
		12	VBAT
		13	FIELD-KICK
		14	FIELD
		15	LOAD-CMD
		16	VSYS
P4 is a 4 pin connector that connects to the heart rate sensor.		1	Left +
		2	Left -
		3	Right -
		4	Right +
P11 is a 10 pin connector that connects to the background debug mode signals.		1	/DS
		2	/BERR
		3	Ground
		4	/BKPT /DSCLK
		5	Ground
		6	FREEZE/QUOT
		7	/RESET
		8	IPIPE1/DS1
		9	+5 Vdc
		10	IPIPE0/DS0

Lifecycle Upright Bikes LC95, LC91, LC85, C9, C7, 95Ce, 95Ci, 93Ci, and 90C
ALTERNATOR CONTROL BOARD - Model C7 and LC8500

Functional Description

The Alternator Control Board is designed to regulate the alternator voltage by modulating the field current. It regulates the pass current (RPM signal) from the Alternator to the Console, and the pass current from the alternator to the load resistor while providing supply voltage for the console while charging the system battery.

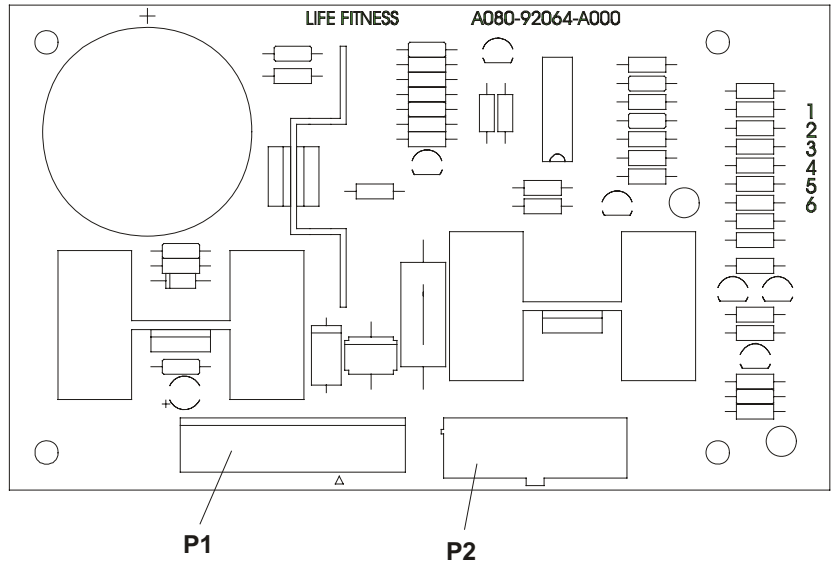

Connector and Pin Connections

Connector	Location	Pin	Functional Description
P1 is a Molex 9 pin connector that connects to the console.		1	RPM (0-7.5 VDC)
		2	VBAT (9VDC)
		3	NOT USED (BLANK)
		4	LOAD
		5	START
		6	GROUND
		7	GROUND
		8	ALTREGLO (9-11 VDC)
		9	VSYS (7-8 VDC)
P2 is a 14 pin connector that connects to the alternator and power resistor.		1	FLD RTN
		2	FIELD (1-4 VDC)
		3	VALT (10 VDC)
		4	LOAD
		5	LOAD
		6	GROUND
		7	GROUND
		8	RPM (0-7.5VDC)
		9	VALT
		10	LOAD
		11	LOAD
		12	GROUND
		13	GROUND
		14	GROUND

**Lifecycle Upright Bikes LC95, LC91, LC85, C9, C7, 95Ce, 95Ci, 93Ci, and 90C
ALTERNATOR CONTROL BOARD - Model C9, LC9100, and LC9500**

Functional Description

The Alternator Control Board is designed to regulate the alternator voltage by modulating the field current. It regulates the pass current (RPM signal) from the Alternator to the Console, and the pass current from the alternator to the load resistor while providing supply voltage for the console while charging the system battery.

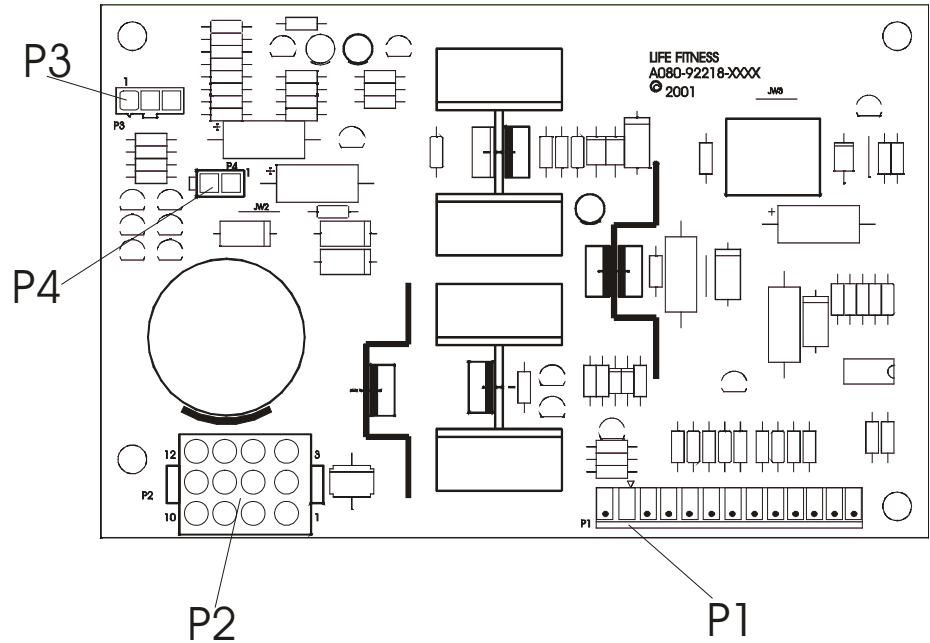

Connector and Pin Connections

Connector	Location	Pin	Functional Description
P1 is a Molex 11 pin connector that connects to the console.		1	GROUND - BLACK
		2	GROUND – BATTERY
		3	NOT USED (BLANK)
		4	VSYS (7-8VDC)
		5	ALTREGLO (9-11 VDC)
		6	LOADCMD
		7	RPM (0-7.5VDC)
		8	START (7-8VDC)
		9	VBAT – (6VDC)
		10	GROUND – BATTERY
		11	GROUND
P2 is a 12 pin connector that connects to the alternator and power resistor		1	GROUND – ALTERNATOR
		2	GROUND – ALTERNATOR
		3	GROUND – ALTERNATOR
		4	RPM (5VDC)
		5	GROUND – ALTERNATOR
		6	FIELD (1-4 VDC)
		7	LOAD
		8	LOAD
		9	LOAD
		10	VALT (10VDC)
		11	VALT (10VDC)
		12	LOAD

**Lifecycle Upright Bikes LC95, LC91, LC85, C9, C7, 95Ce, 95Ci, 93Ci, and 90C
ALTERNATOR CONTROL BOARD - Model C9, LC9100, and LC9500**

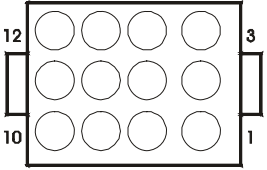
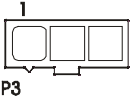
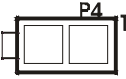
Connector	Location	Pin	Functional Description
P2 Connector is a 12 pin Molex connector that connects to the Alternator.		1	GND
		2	GND
		3	GND
		4	RPM-ALT
		5	GND
		6	FIELD
		7	VALTR
		8	VALTR
		9	VALTR
		10	VALT
		11	Valt OPEN
		12	VALTR
Connector	Location	Pin	Functional Description
P3 is a 3 pin connector that connect to the reed Switch		1	GND
		2	Vbat
		3	RPM-REED
Connector	Location	Pin	Functional Description
P4 is a 2 Pin connector that provides external power (LC95 only).		1	
		2	

Lifecycle Upright Bikes LC95, LC91, LC85, C9, C7, 95Ce, 95Ci, 93Ci, and 90C
ALTERNATOR

Functional Description

The 12 volt, 35 amp Alternator is designed to provide electrical power to the product, supply load resistance while providing electrical power, and provide the RPM signal from the AC TAP to the Alternator Control Board.

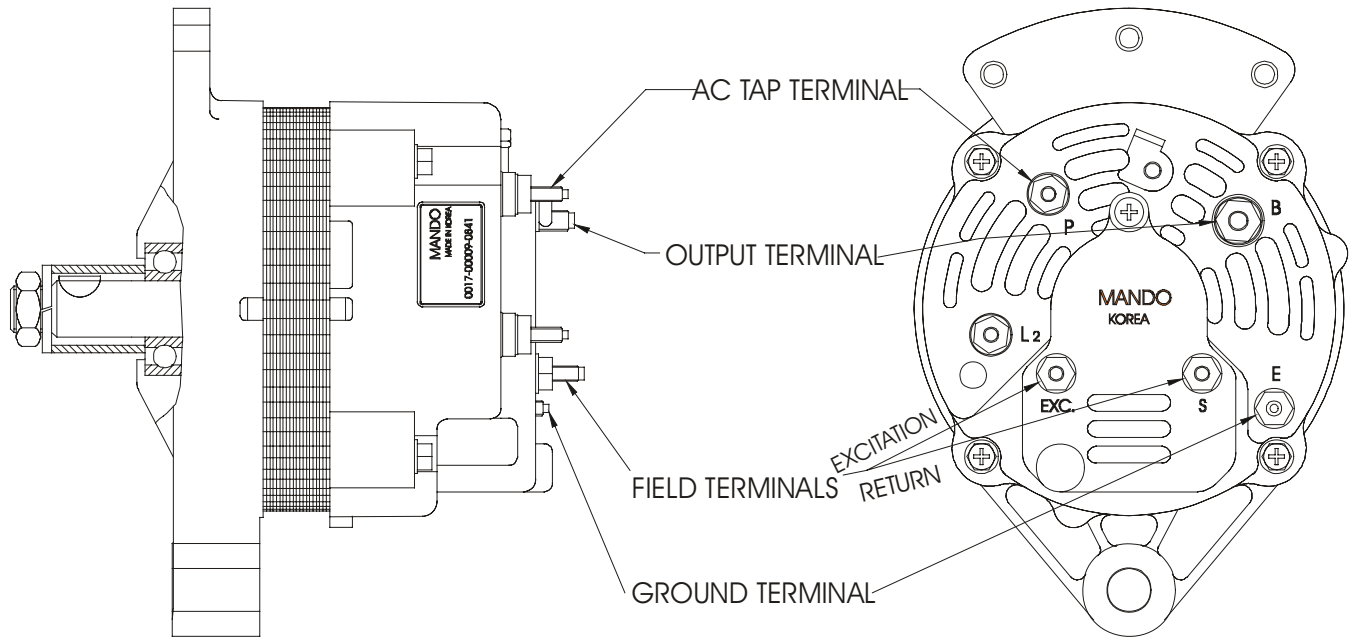

Lifecycle Upright Bikes LC95, LC91, LC85, C9, C7, 95Ce, 95Ci, 93Ci, and 90C

WIRING BLOCK DIAGRAM LC8500 and C7

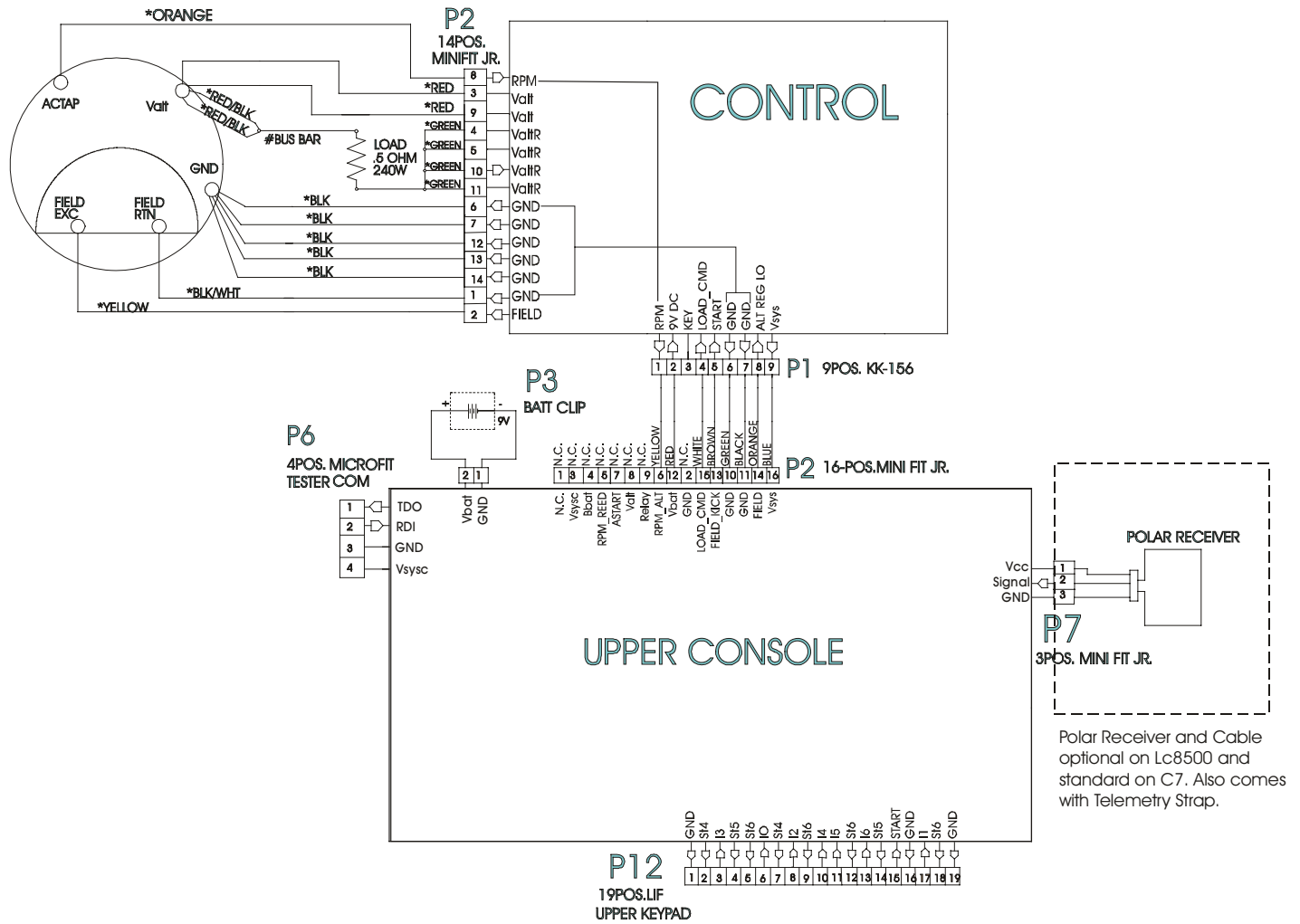

Lifecycle Upright Bikes LC95, LC91, LC85, C9, C7, 95Ce, 95Ci, 93Ci, and 90C

WIRING BLOCK DIAGRAM C9

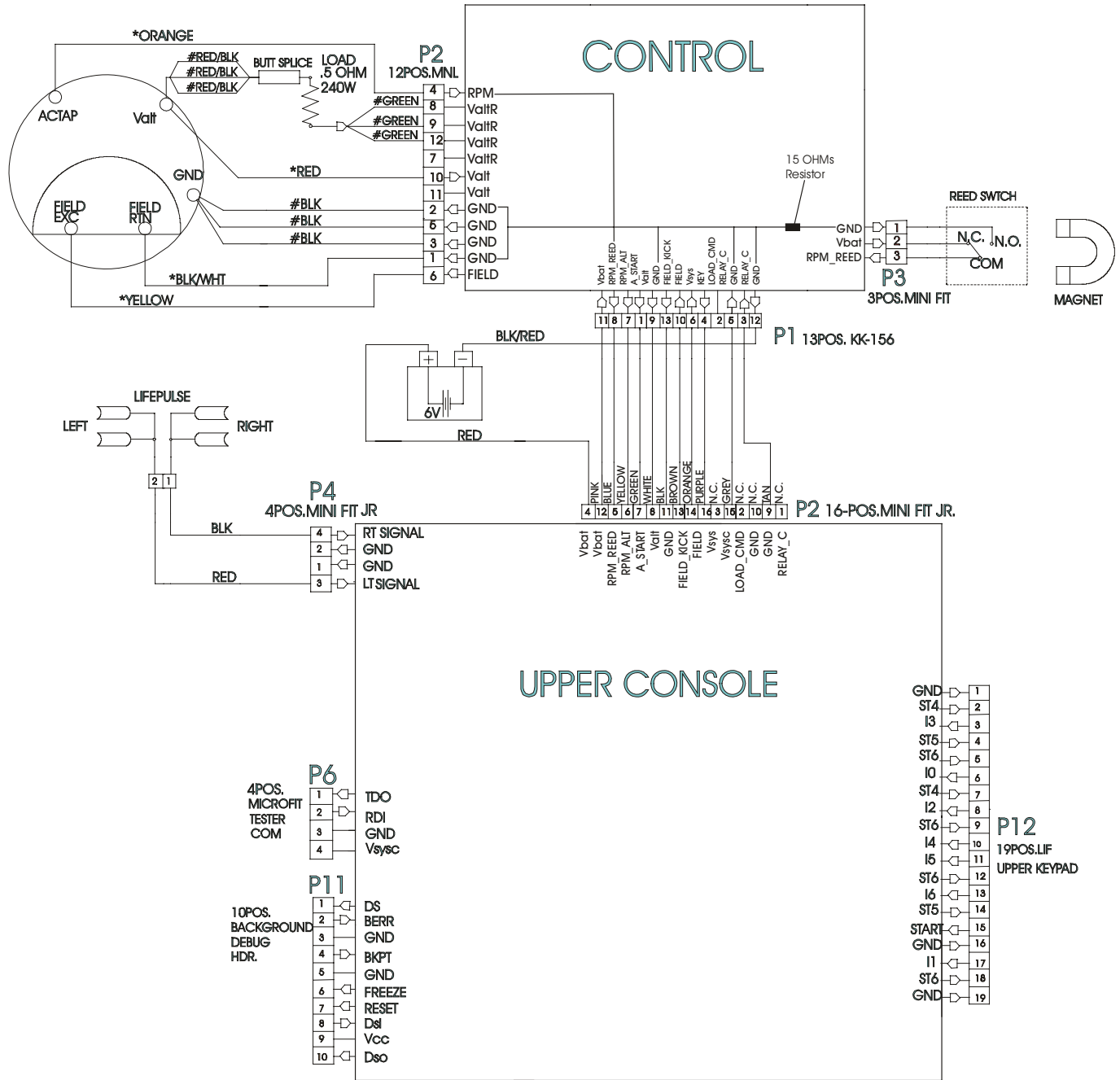

Lifecycle Upright Bikes LC95, LC91, LC85, C9, C7, 95Ce, 95Ci, 93Ci, and 90C
WIRING BLOCK DIAGRAM LC9100

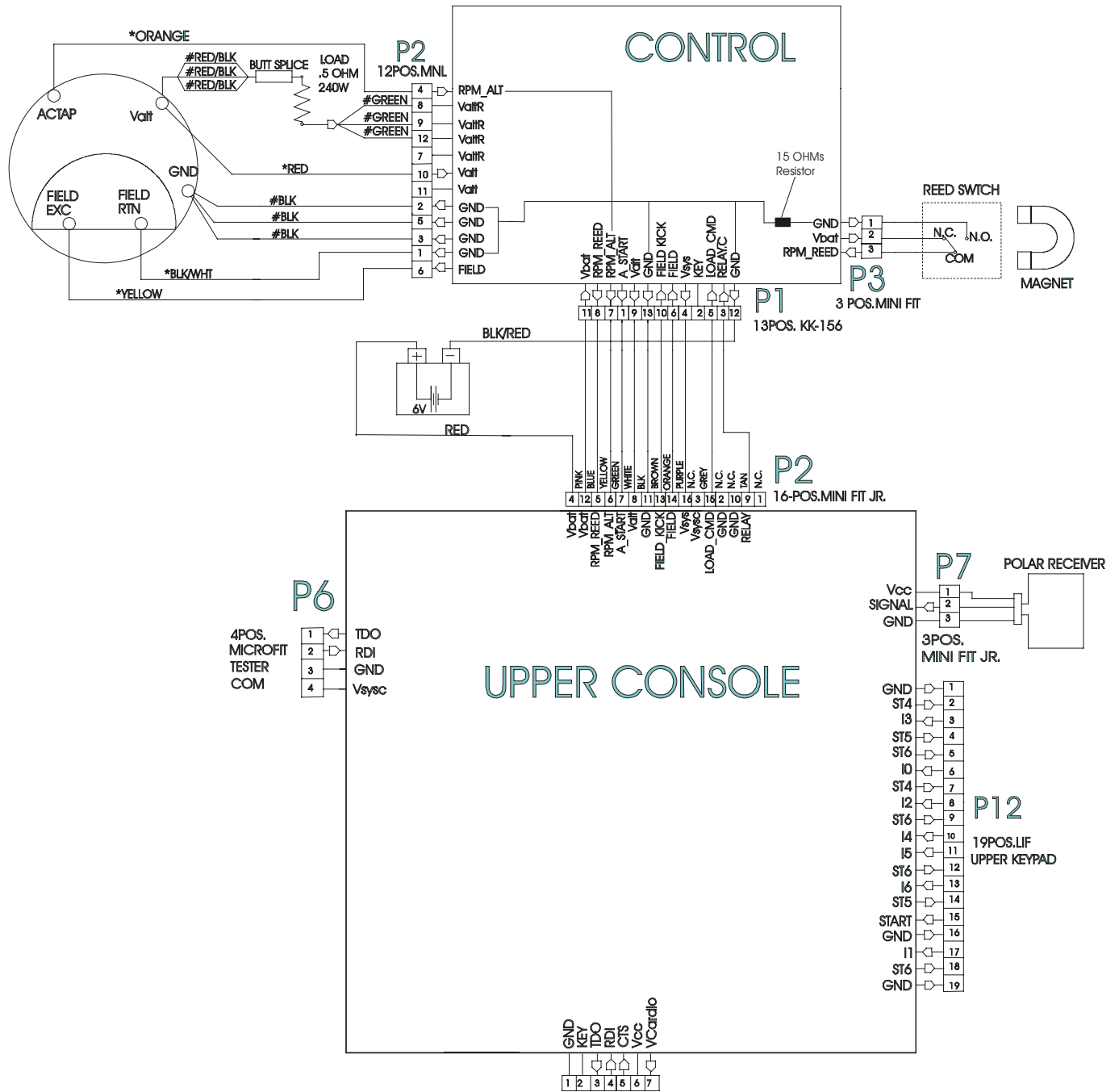

Lifecycle Upright Bikes LC95, LC91, LC85, C9, C7, 95Ce, 95Ci, 93Ci, and 90C WIRING BLOCK DIAGRAM LC9500

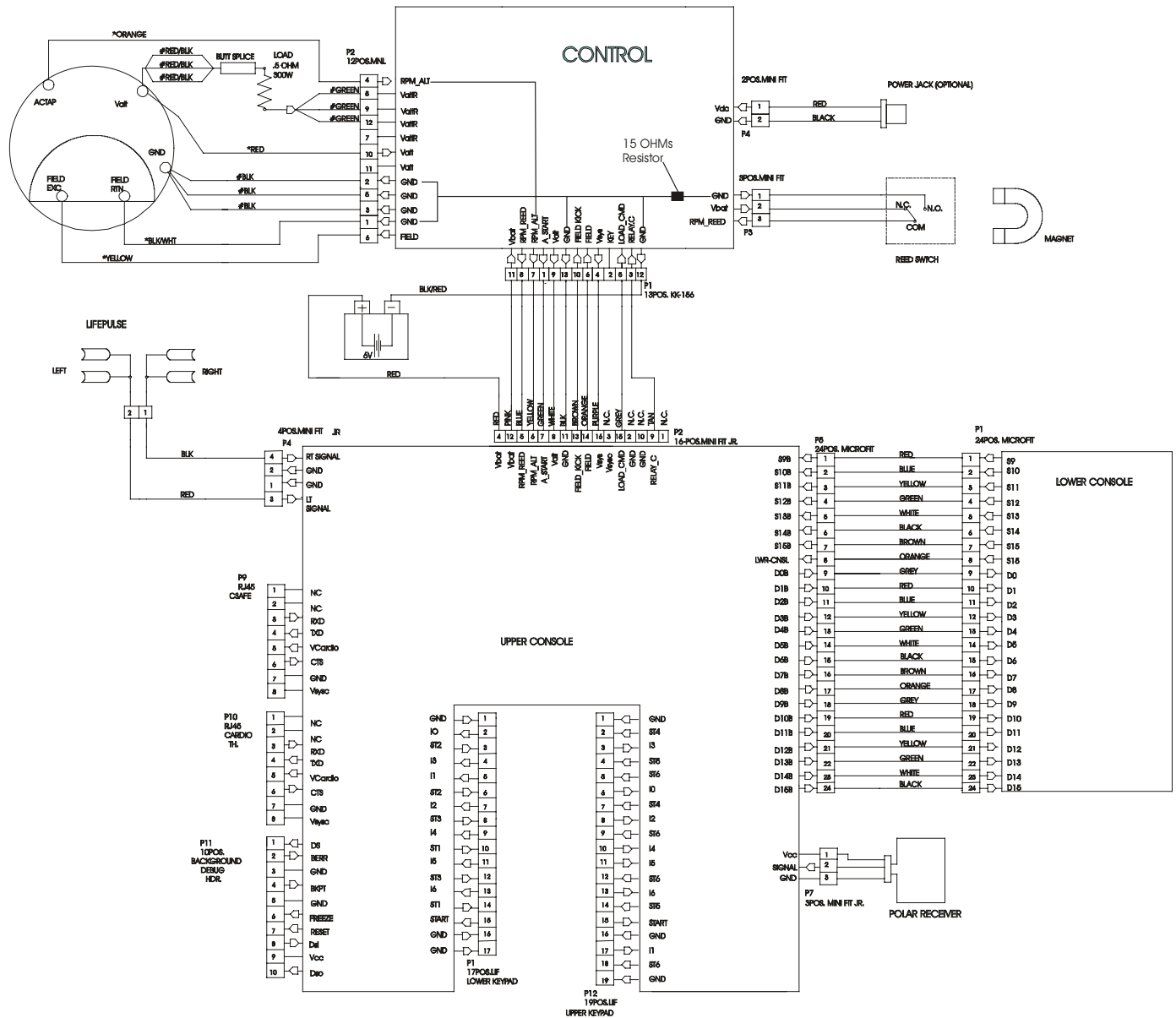

**Lifecycle Upright Bikes LC95, LC91, LC85, C9, C7, 95Ce, 95Ci, 93Ci, and 90C
WIRING BLOCK DIAGRAM 95Ce**

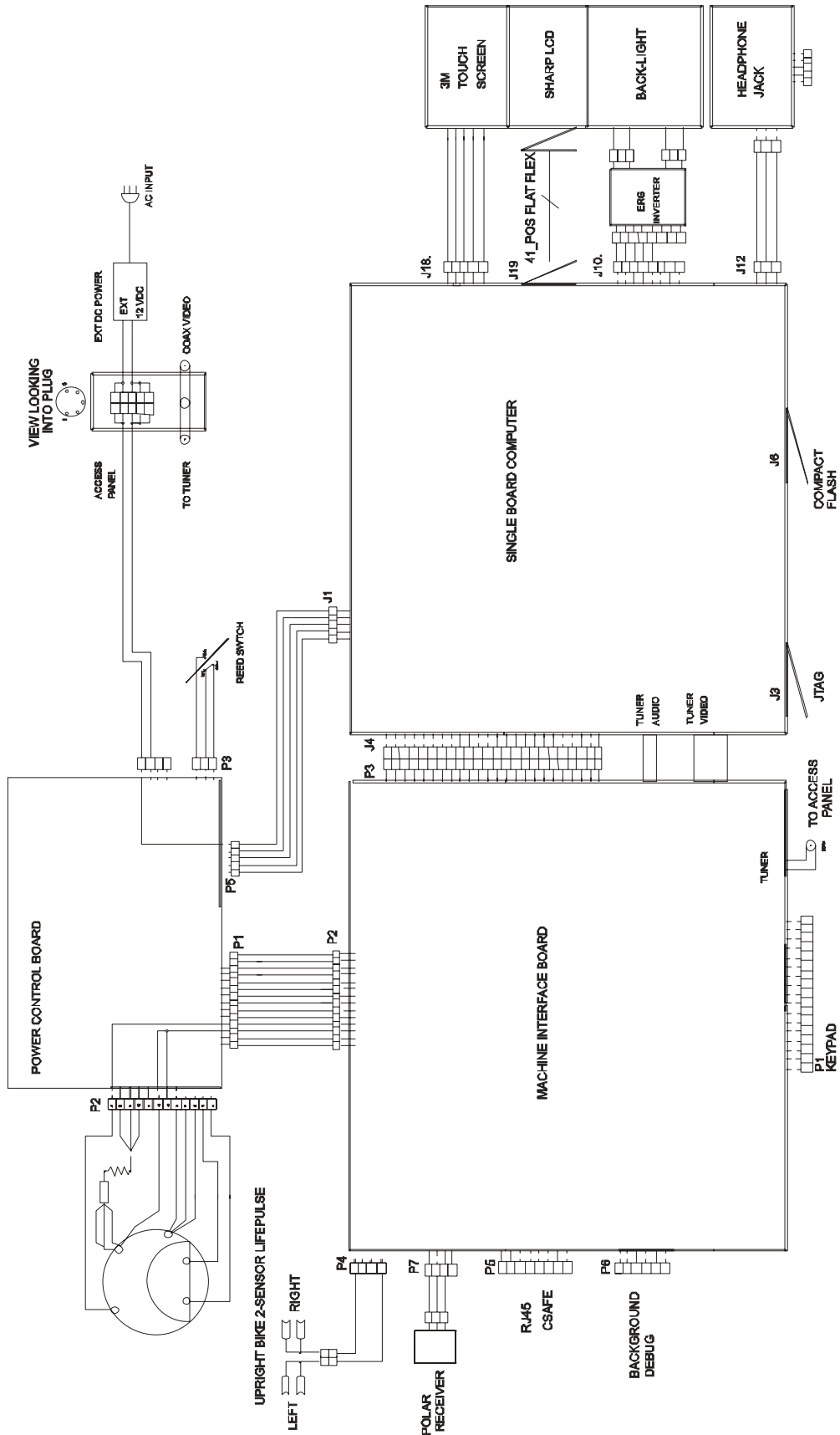

Lifecycle Upright Bikes LC95, LC91, LC85, C9, C7, 95Ce, 95Ci, 93Ci, and 90C

WIRING BLOCK DIAGRAM 95Ce

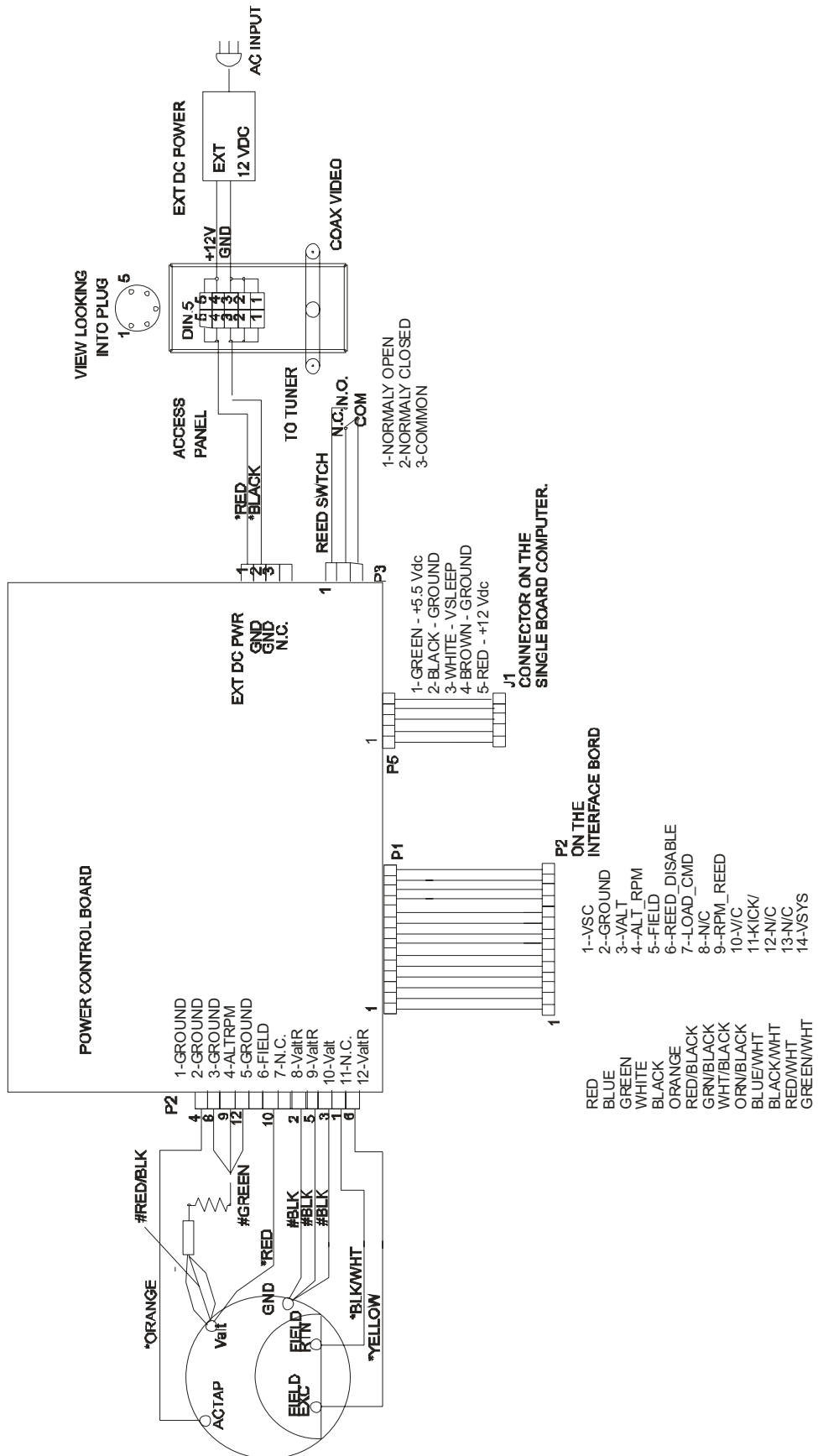

Lifecycle Upright Bikes LC95, LC91, LC85, C9, C7, 95Ce, 95Ci, 93Ci, and 90C

WIRING BLOCK DIAGRAM 95Ce

Machine Interface Board

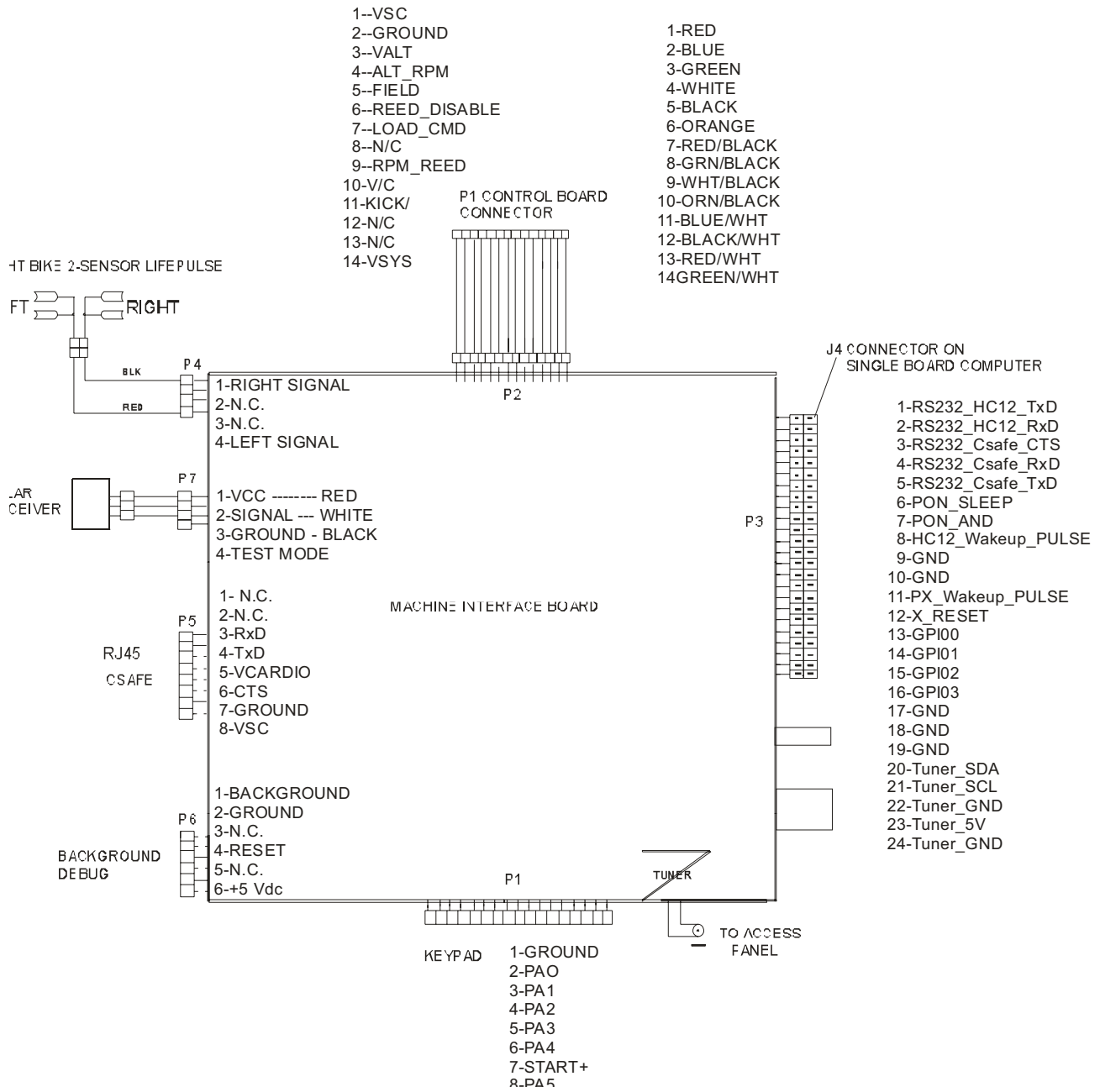

Lifecycle Upright Bikes LC95, LC91, LC85, C9, C7, 95Ce, 95Ci, 93Ci, and 90C

WIRING BLOCK DIAGRAM 95Ce

Single Board Computer

